

We are proud to announce our exclusive National Stocking Distributorship for HOPPE® North America. We have over 500 SKU's available for immediate shipment. HOPPE® North America is one of the leading manufacturers of door hardware.

These pages are designed to give you a sampling of the various products and finishes HOPPE® has to offer. HOPPE's® Single Design Theme is unique to the door industry and has changed and upgraded the look of American households across the country.

We are dedicated to assisting and servicing you on acquiring the quality products from HOPPE® North America.



Do you want the hardware on your entry door, interior doors, patio door and windows to match? Who wouldn't? HOPPE® North America, Inc. carries the full range of products so you can continue the single design theme throughout your entire home, for all your residential doors and windows.

The HOPPE® North America, Inc. hardware program also includes a wide range of products such as multipoint locks and handle sets with cylinders, plus adjustable hinges for doors and turn & tilt hardware for windows. Why hasn't anyone thought of this before? Bet you are glad we did.

# Single Design Theme Handles

## Styles and Finishes

Contact account manager for part numbers and prices.



**Athinai Series in Polished Chrome with Brushed Stainless Steel**

Reminiscent of a strong heritage, the classic sleek curves of the Athinai Series will accent the décor of any room.



**München Series in Polished Chrome**

Curves and flair distinguish the München Series handles. Reminiscent of hearty European design, your traditional handles will stand the test of time throughout your home.



**Verona Series in Polished Brass**

Soft, sleek lines add to the contemporary design of your home. Available in interior and entry functions, Verona Series handles will compliment every room in your home.



**Ródos Series in Satin Nickel**

Majestic and regal, Ródos Series handles represent the ultimate in decorative, European styling and decoration throughout your home.



**New Orleans Series in Matte Black**

Time honored traditional design will complement the style of your home. With slim, lustrous form, New Orleans series handles are the right fit for every member of the family.



**Toronto Series in Antique Brass**

With a touch of provincial and a touch of cosmopolitan, Toronto Series handles complement a wide range of interior designs.



Ródos Series shown with Antique Nickel Finish



New Orleans Series with Brushed Chrome Finish



Toronto Series shown with Oil Rubbed Brass Finish



Polished Brass (F77-R)



White (F9010)



Brushed Chrome (F41-R)

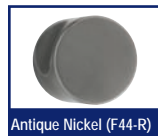

Antique Nickel (F44-R)



Polished Chrome (F49-R)



Brown (F05)



Antique Brass (F73)



Matte Black (F9714)



Oil Rubbed Brass (F79)



Nickel (F01)



Satin Nickel (F42-R)



Rustic Umber (F8709)

München Series

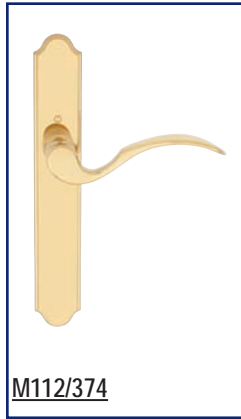
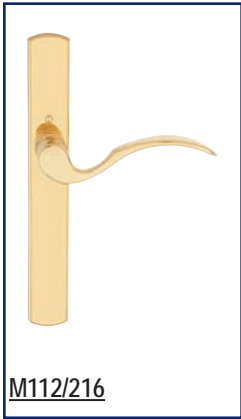

Verona Series

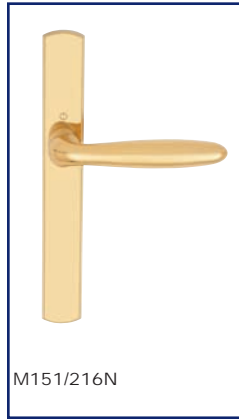

New Orleans Series

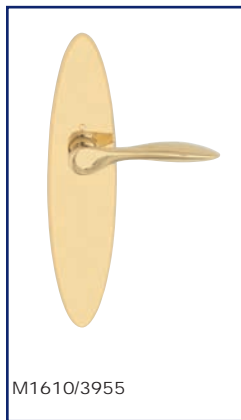

Ródos Series

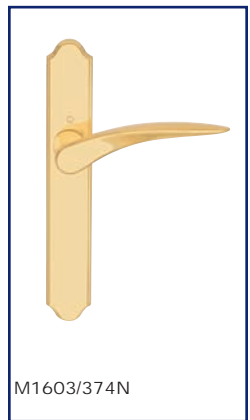
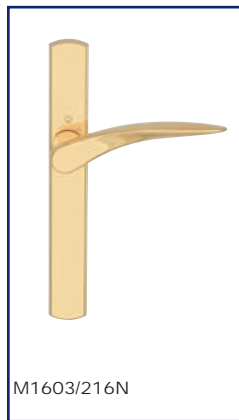

Toronto Series

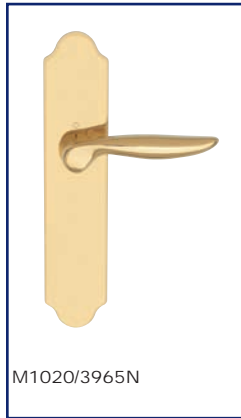
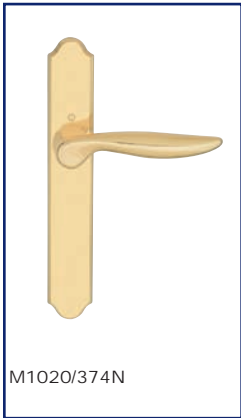

Athinaí Series

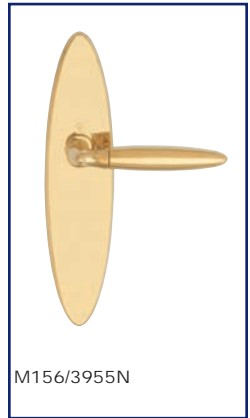
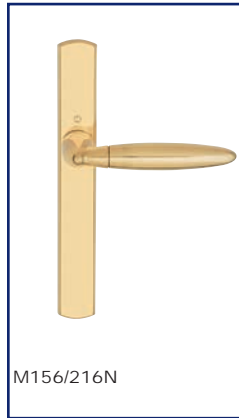

Back Plates, Handles, Bushing, etc. are available separately.  
All HOPPE® Swing Door Handles are available in Active, Inactive and Dummy sets.  
Contact account manager for pricing

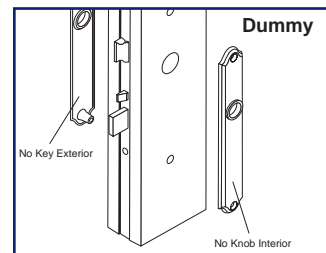
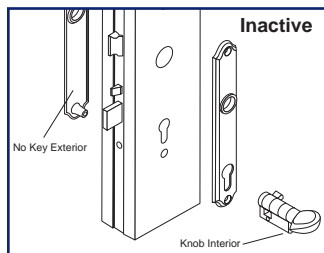
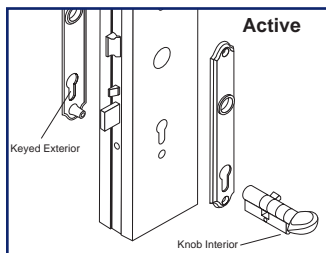

Cylinders See page 261 for other available finishes

All HOPPE® Cylinders are available in Full and Thumbturn Insert Sizes.

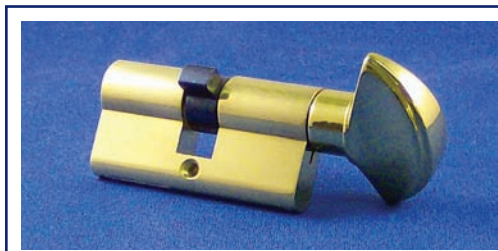

90° Full Cylinder with Crescent Knob

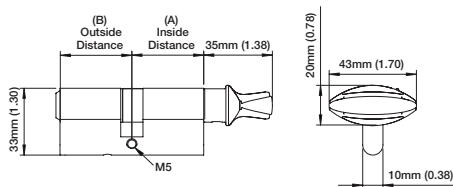

A	B	Part #	Finish
31.5	31.5	850-8787819	Resista Polished Brass
31.5	31.5	850-8762031	Antique Brass
31.5	31.5	850-8761999	Polished Chrome
31.5	31.5	850-8762007	Resista Brushed Chrome
31.5	31.5	850-8762055	Matte Black
31.5	31.5	850-2144956	Oil Rubbed Brass
31.5	31.5	850-2036322	Resista Satin Nickel
31.5	31.5	850-2095904	Antique Nickel



H-Knob



V-Knob

High quality and high security is what you demand from products like cylinders, security systems and locks. HOPPE® provides the highest-quality profile cylinders in the world—the ones we use on all of our swing door systems. These solid brass cylinders are five pin rekeyable compatible with the Schlage® C keyway. Available in 3 knob styles: Crescent Knob, H-Knob and V-Knob. Contact your account manager for part numbers and prices.

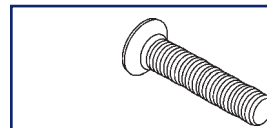

Cylinder Screws

Part #	Description
850-8773863	50mm Stainless Steel
850-2406936	60mm Stainless Steel



90° Thumbturn Insert Cylinder w/Crescent Knob

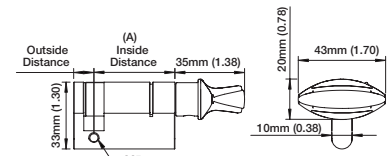

A	B	Part #	Finish
31.5	10	850-8787815	Resista Polished Brass
31.5	10	850-8761911	Antique Brass
31.5	10	850-8761887	Resista Brushed Chrome
31.5	10	850-2144981	Oil Rubbed Brass
31.5	10	850-2036349	Resista Satin Nickel

## Rekeying Kits



Part #	Description
850-8785239	Standard - 100 cylinder capacity



Part #	Description
850-8785243	Mini-Kit - 10 cylinder capacity



Part #	Description
850-8785231	Key Blanks - Schlage® 5-Pin

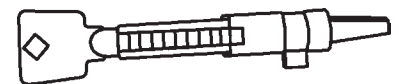

Part #	Description
850-8750635	Blue Plastic Construction Key



Part #	Description
850-2426890	Construction Key

# Multi-Point Locking System

The HLS9000 Stainless Steel Multipoint Locking System provides more than safety and security. It prevents the unwelcome intrusion of rust and corrosion. It can also keep your reputation from being tarnished by eliminating expensive service calls and any resulting loss of revenue.

Corrosion occurs for a variety of reasons. With other materials or finishes, such as yellow zinc dichromate, it can result from pollution in the air, a scratched surface or from the presence of moisture or salt - particularly in coastal regions. Stainless Steel provides excellent corrosion resistance from these in natural atmospheric conditions. It also provides an extra measure of protection from pitting and staining in more demanding locations such as industrial sites, areas of urban pollution and coastal regions. So to protect the quality of your product as well as your image, insist upon HLS9000



SHOOTBOLT  
VERSION



ROLLER  
VERSION



TONGUE  
VERSION



ROUNDBOLT  
VERSION

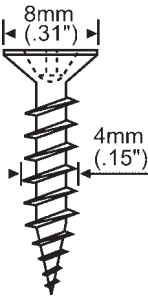

**Screws for Wood Profiles**

Part #	Length
850-8785687	25/32"
850-8785691	1-5/32"
850-8785695	1-3/8"
850-8785699	1-3/4"
850-8785703	1-3/8"

Stainless Steel

Manual/Tongue Shootbolt  
Version

Automatic Four Roller  
Version

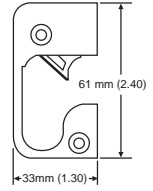
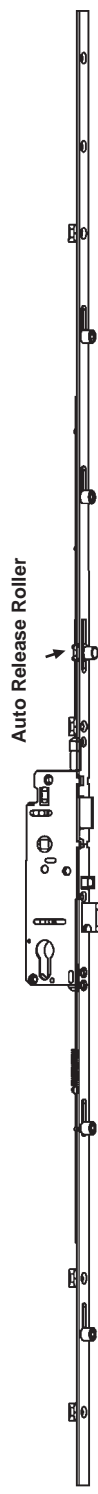
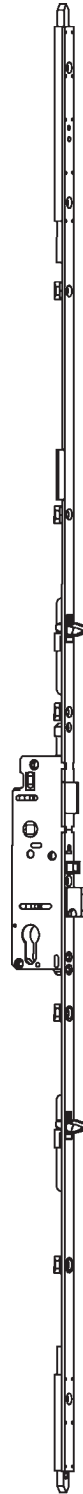

Auto Release Strike

Auto Release Roller

1. The HOPPE® Multi-Point Locking System is a direct replacement for Fuhr Multi-Point Systems.
2. There are various sizes and combinations of these multi-point locking systems. Please fill out the questionnaire and fax it to our sales office to obtain part numbers, pricing and availability.

## MULTIPOINT HARDWARE DOOR QUESTIONNAIRE

Customer Name: \_\_\_\_\_ Account Number \_\_\_\_\_

Contact: \_\_\_\_\_ Phone Number \_\_\_\_\_

1. Which do you see stamped on the thin edge of the metal face plate running up the entire door edge: "FUHR" or "HOPPE®"? (This can be found in between the door latch and deadbolt area) \_\_\_\_\_  
Also, what is the finish of this faceplate?  Brass looking  Stainless Steel
2. Is your door a Swing or Sliding Door? \_\_\_\_\_
3. What is the width across of this metal face plate?  5/8" (16mm)  25/32" (20mm)
4. Do you know who manufactured the door? How about the windows in your home? If so, please list the company: \_\_\_\_\_
5. Is this for a single door or a pair of doors (french doors)? \_\_\_\_\_
6. What is the door thickness:  1 3/4" (45mm)  2 1/4" (57.15mm)  other: \_\_\_\_\_
7. What is the door panel height? (The door panel is the part that opens and closes) height: \_\_\_\_\_
8. What is the distance from the center of the door handle down to the bottom horizontal edge of the door (36" Standard)? \_\_\_\_\_
9. What is the distance from the center of the handle to the center of the thumbturn piece?  
 2-7/32" (56mm)  2-53/64" (72mm)  3-5/8" (92mm)  other: \_\_\_\_\_
10. **BACKSET:** What is the distance from the center of the handle to the door edge (edge with the latch and deadbolt on it, not the edge with the hinges)?  
 1-3/8" (35mm)  1-3/4" (45mm)  2-3/8" (60mm)  2-3/4" (70mm)
11. **DEADBOLT THROW:** With the door ajar, measure how far out the deadbolt extends from the edge of the door:  1/2"  1"
12. Is this a "manual" or "automatic" door? Manual: Must first pull up on handles to operate the multipoint locks or Automatic: where the multi points engage on their own when you close the door?  Manual  Automatic\*  
**\*NOTE: Automatic version will have a small roller-like piece located approximately 7-8" above the latch. See pictures.**
13. Based on the accompanying pictures, please put an "x" by the multipoint system you have:  
 Tongue Automatic  Tongue/Shootbolt Manual  
 Manual Tongue  Roller/Shootbolt Manual  
 2-Roller Automatic  Roundbolt Manual  
 2-Roller Manual  Roundbolt/Shootbolt Manual  
 4-Roller Automatic  Shootbolt Manual  
 4-Roller Manual  Single Point Only: Only has a latch and deadbolt
14. If you have a tongue or roundbolt version, what is the distance from the center of the handle down to the bottom tongue or roundbolt position?  26-27/64" (671mm)  29-21/32" (753mm)  other: \_\_\_\_\_
15. If you have a tongue or roundbolt version, what is the distance from the center of the handle up to the top tongue or roundbolt position? \_\_\_\_\_
16. If you have a roller version (2 or 4 roller, manual or automatic) what is the distance to each of the roller positions from the handle center location? \_\_\_\_\_

Steel Reinforcements – Makes this new hinge the "Ultimate" with door systems.

- Corrosion Resistant – Specially coated components for improved durability and strength.
- Easy Adjustment – Set hinge has a vertical adjustment feature (+/- 2.5mm) Guide hinge has a horizontal adjustment feature (+/- 2mm).
- Maintenance Free Bearings – No oiling required.
- Security – Non-removable pin (NRP) available for increased security.

- Simple Door Preparation – Quick and easy one pass routing.
- Variety of Finishes – Available in finishes to match your HOPPE® handle sets.
- Designed to carry up to 165lbs. per door.
- Not to be used in commercial applications, especially not in conjunction with a door closer.

### Set Hinge

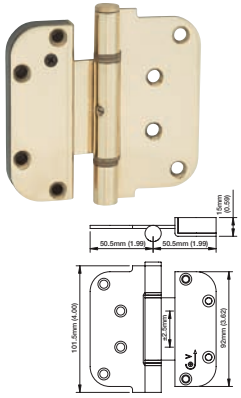

### Steel Set Hinges with Non-Removable Pin

Part #	Finish
850-8762439	Polished Brass
850-8762455	Polished Chrome
850-8762703	Brushed Chrome
850-8762487	White Powder Coat
850-8762519	Gold Powder Coat
850-2307831	Rustic Umber
850-8762535	Matte Black

### Brass Set Hinges with Non-Removable Pin

Part #	Finish
850-8762655	Polished Brass
850-8762671	Antique Brass
850-2086311	Satin Nickel
850-2086354	Antique Nickel
850-8762687	Oil Rubbed Brass

### Guide Hinge

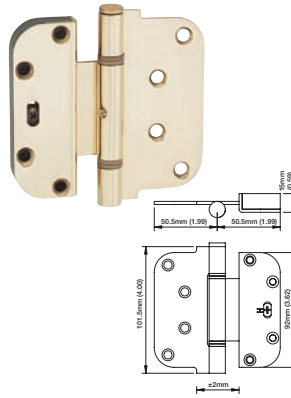

### Steel Guide Hinges with Removable Pin

Part #	Finish
850-8762435	Polished Brass
850-8762451	Polished Chrome
850-8762699	Brushed Chrome
850-8762483	White Powder Coat
850-8762515	Gold Powder Coat
850-2307823	Rustic Umber
850-8762531	Matte Black

### Brass Guide Hinges with Removable Pin

Part #	Finish
850-8762651	Polished Brass
850-8762667	Antique Brass
850-2086303	Satin Nickel
850-2086346	Antique Nickel
850-8762683	Oil Rubbed Brass

## Latch & Deadbolt Screws



### Mounting Screws 2 Per Pack

3/4" Long	1-1/2" Long	Finish
850-2100785	850-2104381	Polished Brass/ Brushed Brass
850-2100793	850-2104399	Antique Brass
850-2100831	850-2104436	Brushed Chrome/ Satin Nickel

3/4" Long	1-1/2" Long	Finish
850-2100814	850-2104410	Polished Chrome/ Brushed Stainless Steel
850-2100822	850-2104428	Oil Rubbed Brass/ Matte Black
850-2100849	850-2104444	Antique Nickel

## Swing Door Accessories

### Single Point Gear Box

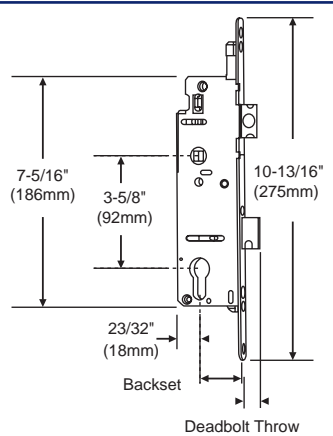

Part #	Backset	Deadbolt Throw
850-8778179	1-3/8"	1/2"
850-8778175	1-3/4"	1/2"
850-8778151	1-3/8"	1"
850-8777959	1-3/4"	1"
850-2881323	2-3/8"	1"
850-2881331	2-3/4"	1"

### Latch & Deadbolt Strike

#### For 1-3/4" Door

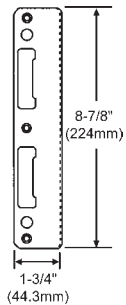

Part #	Finish
850-8787715	Polished Brass
850-8787719	Antique Brass
850-8787735	Matte Black
850-8787723	Polished Chrome
850-8787727	Brushed Chrome
850-8787731	Oil Rubbed Brass
850-8787739	White Powder Coat
850-8787747	Stainless Steel
850-2127443	Satin Nickel
850-2127427	Antique Nickel

Curved Lip with Cylinder Hole and Non-Handed  
Other Configurations Available

#### For 2-1/4" Door

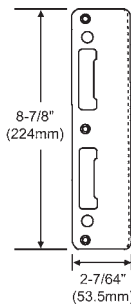

Part #	Finish
850-2014019	Polished Brass
850-2014027	Stainless Brass
850-2014334	Oil Rubbed Brass
850-2014764	Brushed Chrome
850-2014781	Polished Chrome
850-2014799	White Powder Coat
850-2014801	Matte Black Powder Coat

Curved Lip with Cylinder Hole and Non-Handed  
Other Configurations Available

### Dust Cap

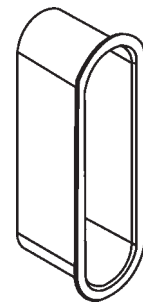

Part #	Finish
850-8786547	Black

For Latch and Deadbolt Strike  
or Tongue Strike

## Tongue Strikes

Part #	Finish
850-8784675	Brass
850-1964522	Stainless Steel
850-2121244	Oil Rubbed Brass

Curved Lip

Part #	Finish
850-2025181	Brass
850-2025199	Stainless Steel
850-2025842	Oil Rubbed Brass

Radius Lip

Part #	Finish
850-8784699	Brass
850-8784707	Stainless Steel
850-8786551	Antique Brass
850-8786559	Brushed Chrome
850-8784703	Oil Rubbed Brass
850-8786575	Matte Black
850-2127486	Satin Nickel

Flat

## Shootbolt Strikes

Part #	Hand	Finish
850-8784095	LH	Brass
850-8784091	LH	Stainless Steel
850-2117325	LH	Oil Rubbed Brass
850-8784067	RH	Brass
850-8783923	RH	Stainless Steel
850-2117261	RH	Oil Rubbed Brass

Curved Lip Single Door

## Shootbolt Strikes

Part #	Finish
850-2135259	Brass
850-2098911	Stainless Steel

Single Door

Part #	Finish
850-2135241	Brass
850-2098945	Stainless Steel

Double Door

## Socket Strikes

Part #	Finish
850-8784663	Brass
850-8784667	Oil Rubbed Brass

3/4" Throw

Part #	Finish
850-2024962	Brass

1" Throw



# LOCCA WIRELESS REMOTE CONTROL ENTRY DEVICES

Ideal for Assisted Living, Retirement Communities, ADA Required Access, Condos & Apartments, Housing Authorities, Gated Communities, Single Family Homes, Hotels, Motels, Resorts, Office Buildings and Retail Outlets. An affordable and simple remote control device for virtually everywhere.

The Locca Wireless Remote Control Entry devices use cutting edge technology that allow you to program up to 999 remotes to access a single entrance. The Locca units meet the requirements of ADA to achieve ease of access for all. The Locca's stylish design offers a more modern form of security for your home, community living or buildings that share one main entry. No more fumbling with your keys when you have heavy shopping bags, groceries or are holding a child. With the Locca Remote, one click and the door is unlocked! For new door installations, the Locca Electronic Device can be used in conjunction with a multi-point locking system for ultimate security. Remote Control Entry Systems are inevitable. We all use remotes to unlock our cars, so why not apply the same technology to open our homes and offices?

## WIRELESS REMOTE CONTROL UNITS

Both Locca Remote Control Entry devices consist of a small unit that's installed on the inside of the property. It is plugged into a standard wall outlet. The unit is wired to the Electronic Strike and is operated with the wireless remote. One click of the button to unlock the door. It's as simple as that!

### Locca Access Control Unit

56-1

The Locca ACCESS Unit is the electronic system that unlocks your door with a single click.



- Up to 19 remotes can be stored
- One-touch programming
- Range from up to 50 yards
- Rolling code technology
- No electrical expertise required (transformer plug included)
- Incredibly easy to install and use
- No training required
- Kit comes with 1 Red Programming Remote, 2 Lifestyle Remotes, 1 Electronic Latch Strike
- Can be upgraded with the wireless intercom system.



### Locca Multi Control Unit

56-2

The Locca MULTI unit uses the same cutting-edge technology as the ACCESS unit to unlock your doors with a single click, but with additional benefits.



- Up to 999 remotes can be stored
- On Screen programming
- Range selection from 1.5 yards up to 50 yards
- Program individual offices in a large complex, w/ shared entrance
- Rolling code technology
- No electrical expertise required (transformer plug included)
- Durable and reliable
- Incredibly easy to install and use
- No training required
- Kit comes with 1 Red Programming Remote, 2 Lifestyle Remotes, 1 Electronic Latch Strike
- Can be upgraded with the wireless intercom system.



## REMOTES & STRIKE

### Lifestyle Remote Key

56-7

- Stylish design
- Key ring size
- Covered button
- Up to 50 Yard range



### SureTouch Remote Key

56-6

- Designed especially for the elderly and disabled
- Yellow on black for the visually impaired
- Wrist and neck straps provided
- Low resistance button, easy to push
- Up to 50 yard range



### Electronic Strike

56-9

Locca's systems have been designed to be totally versatile, to work with a variety of locks and accessories.



## LOCCA WIRELESS INTERCOM SYSTEM

The Connecta Wireless Intercom System enables you to speak to a visitor with a single click of the handset. The Connecta is a great tool for homes as well as commercial buildings where it is necessary to identify guests prior to unlocking the door for them. Each Connecta Intercom Unit can take up to 6 portable handsets that can be placed on different floors of a home or other offices in a building. They can also be used as an internal intercom between handsets. The handsets have a range of up to 200 yards.

*Intercom Transmitter Kit & Handheld Receiver*  
56-3

*Remote Hand Held Receiver Only*  
56-8



## COMBINATION WIRELESS REMOTE CONTROL ENTRY & INTERCOM SYSTEM

The Locca Combination Kits allow you to speak with and identify guests. Then using the same hand held unit, you can automatically unlock your door to allow access.

*Intercom Transmitter Kit & Handheld Receiver w/Access Control Unit*  
56-4

*Intercom Transmitter Kit & Handheld Receiver w/Multi Control Unit*  
56-5



### Kit includes:

- 1 Portable Handheld Intercom
- 1 Base Unit for the Exterior of Building or Gate
- 1 Plug in for Power to the Base Unit
- 1 Recharging Cradle for the Handset and power cord
- 1 Access or 1 Multi Remote Control Entry Unit



Please contact your sales representative for information on using the Locca Wireless Remote Control Entry Device in conjunction with our multi-point locking systems.

# Swing Door Hardware

## Swing Door Handle Sets

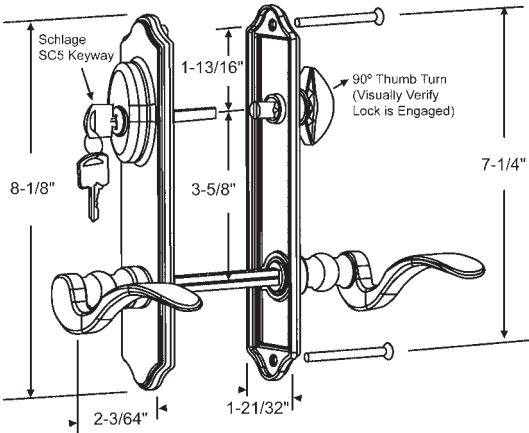

Used by Milgard, Marvin, Jeld Wen (Caradco), Cantera, Delta and PGT  
All the above swing door trim sets are for a 1.7 (1-3/4") door. For 2.0 (2") door (used by PGT), you need to order a #16-483(color) 2" adapter kit. (Includes longer screws, longer shaft and tailpiece).  
Check for colors available for 2.0 (2") application.

Active (Shown) - Thumb Turn w/Key

Part #	Finish
55-101AB	Antique Brass
55-101BC	Brushed Chrome
55-101BRS	PVD Brass
55-101ORBZ	Oil Rubbed Bronze
55-101SNK	Satin Nickel
55-101PB	Polished Brass
55-101PC	Polished Chrome
55-101W	White

\*Passive - No Thumb Turn, No Key

Part #	Finish
55-102AB	Antique Brass
55-102BC	Brushed Chrome
55-102BRS	PVD Brass
55-102ORBZ	Oil Rubbed Bronze
55-102SNK	Satin Nickel
55-102PB	Polished Brass
55-102PC	Polished Chrome
55-102W	White

\* When Using the Passive Swing Door Trim Set as a Dummy Set You Need to Order a #16-482 Dummy Plate

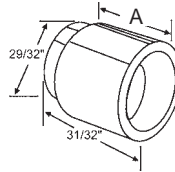

Part #	"A"
39-713(Color)	3/8"
39-714(Color)	3/4"

Handle Extension

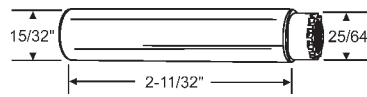

59-67  
Tool

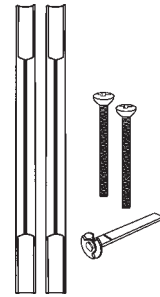

16-483(Color)  
2" Adapter Kit

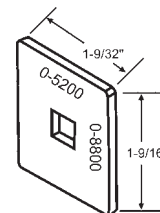

16-482  
Dummy Plate

### Prado Active Swing Door Handle Set

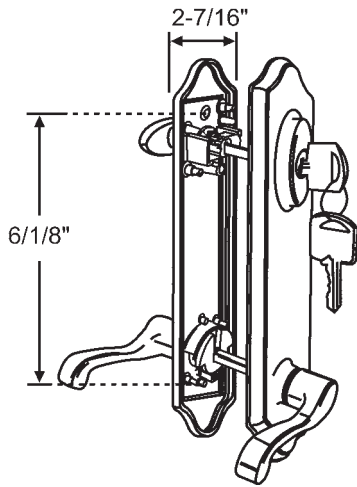

- Fits 2-1/8" Cross Bore on 6-3/32" Centers.
- Fits All Peachtree Prado Patio Doors
- Fits Right or Left Hand Doors

Part #	Finish
55-146AB	Antique Brass
55-146PB	Polished Brass
55-146CP	Chrome Plated

This lockset also can be used on older Prado doors with a 1-3/4" cross bore.

**Peachtree**



### Swing Door Handle Set A Suitable Pella Replacement

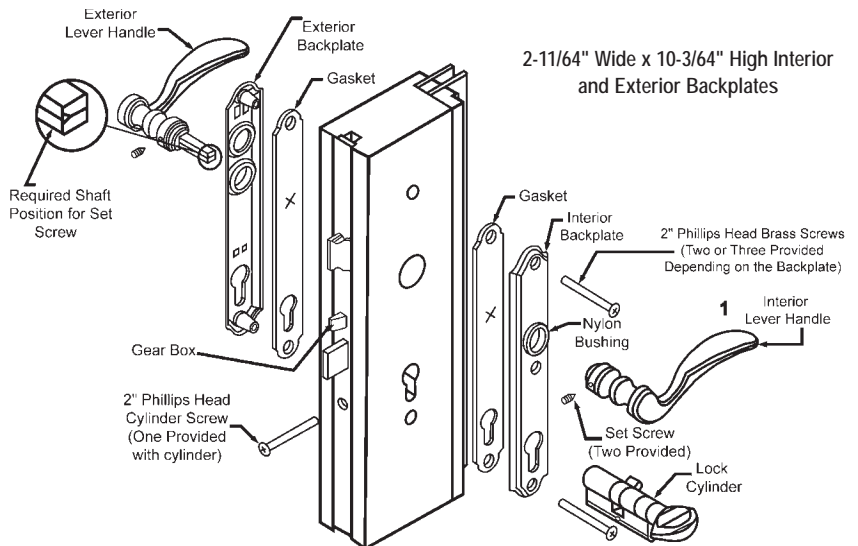

Part #	Description
850-2422063	Active Handle Set (shown)
850-2422338	Inactive Handle Set

New Resista Brass Finish (F77-R)

## Swing Door Handle Sets

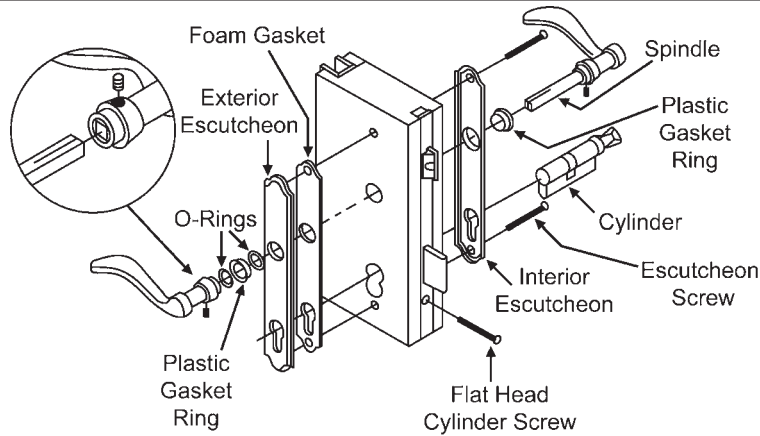

Handle Set Assembly

Part #	Finish
55-111BRS	Brass
55-111AB	Antique Brass
55-111BC	Brushed Chrome
55-111CP	Chrome Plated



## New Style Gear Box for Multi Point Systems

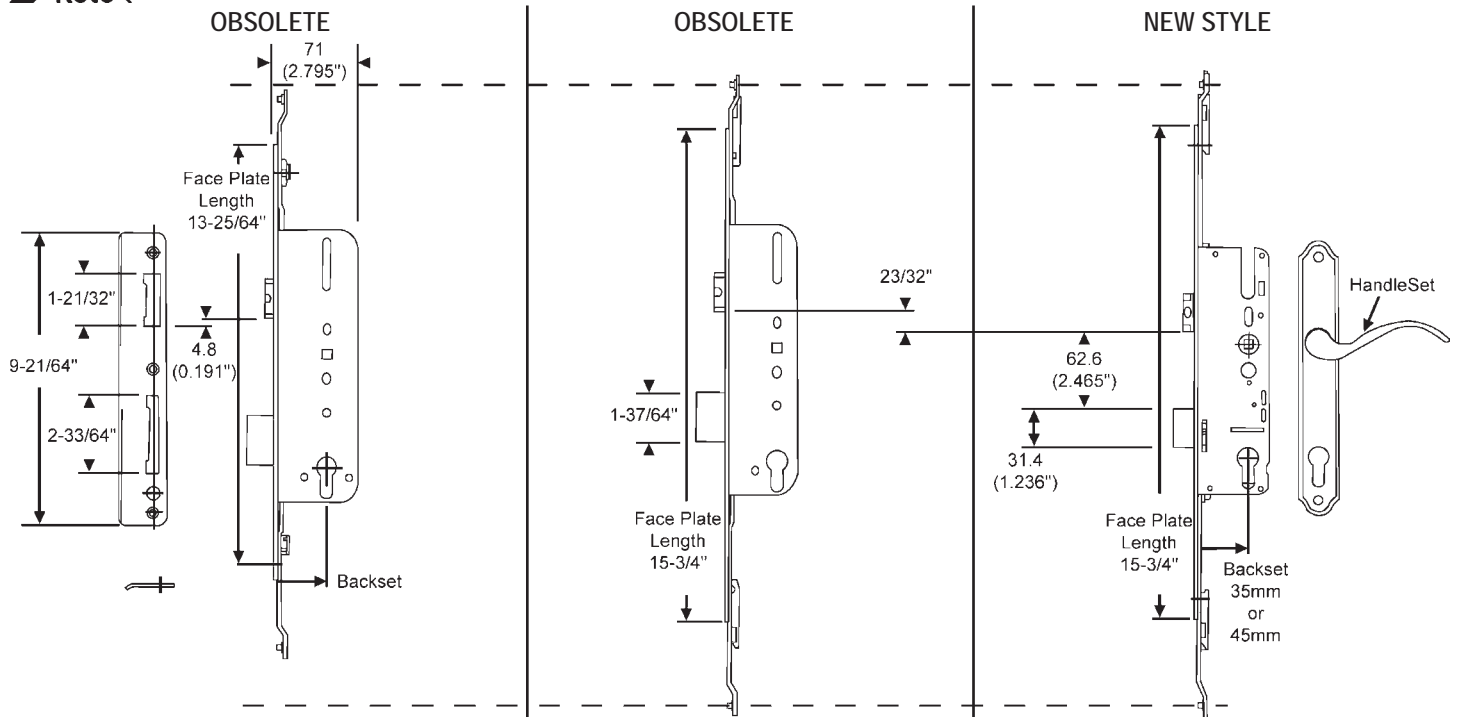

ALL SHOWN IN LOCKED POSITION

NOTE: If replacing an old style Gear Box (see the 2 listed as obsolete) with the New Style Gear Box (see 56-106 or 56-105 listed above) the door will need to be notched out 23/32", to accept the position of the New Style Gear Box. Also the Strike Plate needs to be lowered 23/32", to line up properly with the latch and Dead Bolt on the New Gear Box. Any questions please contact your sales Representative

Part #	Hand
12-313PB	Shown
12-314PB	Opposite

Brass Strike

Part #	Backset
56-106	35mm
56-105	45mm

Gear Box

## Eurogroove Stepped Router Bits

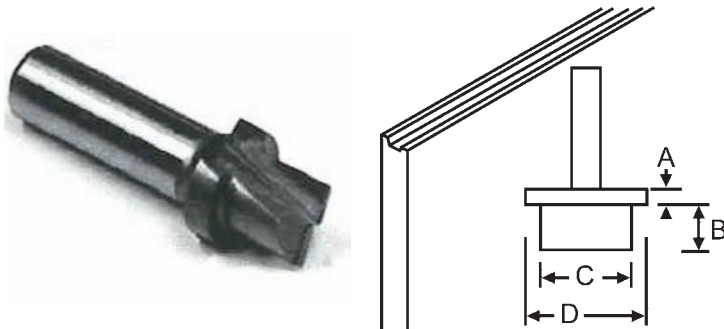

SBI #	MFG.	A	B	C	D
59-69S	Schlegel	1/8"	1/4"	3/4"	1"
59-69T	Truth	1/8"	13/32"	9/16"	51/64"
59-69GU	GU	3/32"	3/8"	31/64"	21/32"
59-69R	Roto- Frank	3/32"	23/64"	31/64"	5/8"
59-69	Hoppe	1/8"	23/64"	1/2"	5/8"
59-69W	Winkhaus	3/32"	23/64"	31/64"	51/64"
59-69W-1	Winkhaus	3/32"	23/64"	31/64"	41/64"